

## Was sind die Details unserer LED? Light Bard.?

Druckguss-Aluminiumgehäuse, Oberflächenbehandlung für elektrostatische Beschichtung  
UV-Stop-PC-Lampenabdeckung  
Versiegelte Lampengehäuse.

## Was sind die Spezifikationen von uns? [GETRAGEN Light Bard.?](#)

Isolationsklasse	Stromversorgung	LED-Strom	Leistungsfaktor	Arbeitsumgebung	Dauer	CRI.	Cct.
Klasse I.	120-277V. 50 / 60Hz.	700mA.	> 0,95.	-35. ° C bis +45 ° C	> 30.000 Stunden	Ra> 75.	3000K-6500K.

Produktcode	YMELED-6218.
Menge LED.	4 Stück.
Nominelle Kraft	8w.
Lichtstrom	500-600lm.
G.w / n.w.	5 / 4,5kg.
Packungsgröße	250x250x830mm.

## Produktfoto.



# YM-6218

RAL 7015



RAL 9005



**Die cast aluminum housing**  
**CREE LED Chip / Meanwell driver**  
**Height can be customized**



**CE** IP65

## Certificate

# Certificate



# Product Dimensions(mm)

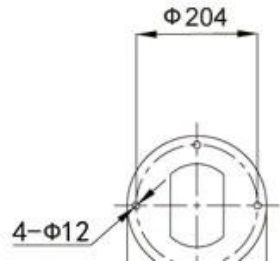
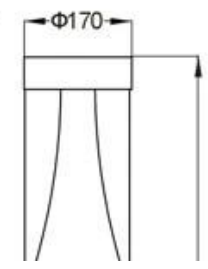

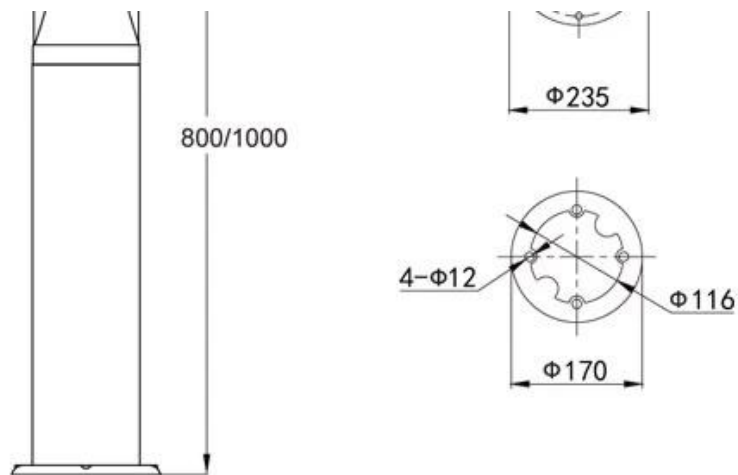

## Configuration Data:

Protection grade	Corrosion-proof capability	Working condition	Isolation class	Power voltage	Max power
IP65	II 类	-35°C ~ +45°C	class I	120~277V 50/60Hz	8W(SMT)





# Company Profile

Yuyao Yangming Lighting Co., Ltd. is mainly engaged in the development and production of garden lighting. Founded in 2001, it has developed more than 200 kinds of Garden lights, street lights, lawn lights, footpath lights, light poles, led lights and wall lights.

Now we are creating our own brands and developing products suitable for market. Welcome all friends to contact us. We will make contribution to lightening your home.





# Testing and Design

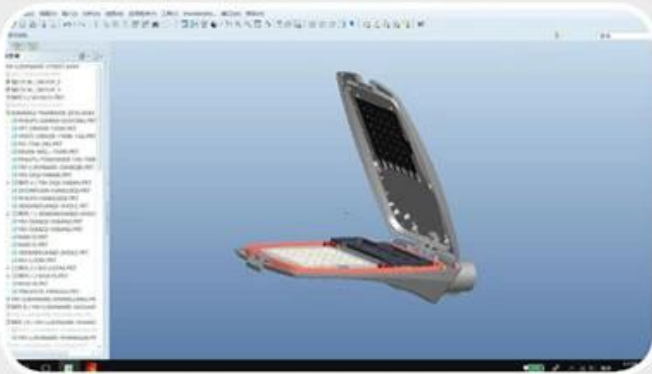

product design



ingress protection (Ip) testing equipment.



led street lighting aging testing line.

ingress protection (IP) testing equipment

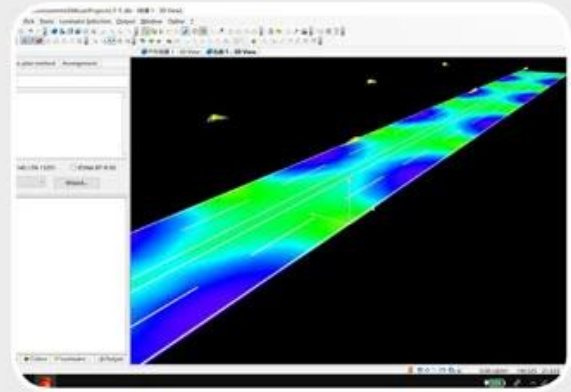

road lighting simulation

ullbrich sphere for testing luminous flux

# Exhibittion

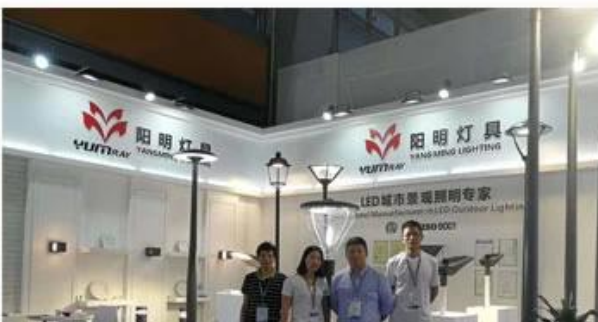
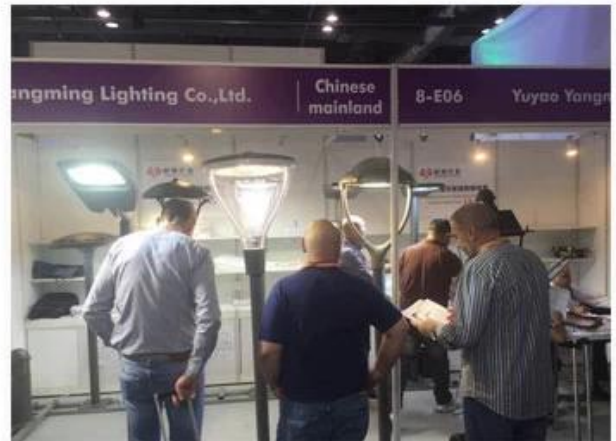



Add : Minyin industrial Zone, Liangnong Town,  
Yuyao,Zhenjiang,China

Sale: 0574-22222345 / 22719888

0574-22672345(Fax)

Hotline: 0574-62359099

0574-62359077(Fax)

Http://www.ym-lighting.com

www.yyym2001.1688.com

www.yangminglamps.en.alibaba.com



## Verpackung und Versand, Geschäftsbedingungen:

### Sendung

- 1 **FedEx / DHL / UPS / TNT** zum **Proben**, Tür zu Tür,
- 2 **Mit der Luft oder auf dem Seeweg** zum **Chargen**für FCL; Flughafen / Port, der empfängt,
3. Kunden, die Handelsanschlüsse oder Versandmethoden angeben,
4. **Lieferzeit:** 5.-7 Tage für Proben; fünfzehn-30. Tage für Chargenwaren.

### Zahlungsbedingungen

1. Zahlung: **T / t., Western Union, MoneyGram., PayPal. 30% Ablagerungen. 70% Restbetrag.** vor der Lieferung,
- 2 **MOQ: 1 Stück,**
3. Garantie: 5 Jahre