

Was sind die Spezifikationen unserer [LED Gartenlicht](#)?

Isolationsklasse	Stromversorgung	LED-Strom	Leistungsfaktor	Arbeit umgebend	Lebensspanne	Krise	Kg
Klasse I.	120-277V. 50 / 60Hz.	700ma.	> 0.95.	-40. ° C bis +55 ° C	> 50.000 Stunden.	Ra> 75.	3000K-6500K.
Produktcode	YMLED-6109 (16)		YMLED-6109 (20)		YMLED-6109 (24)		YMLED-6109 (28)
LED-Menge	16 stücke		20pcs.		24pcs.		28 stücke
Nennleistung	35w.		45w.		Mit 55 Watt		Mit 60 Watt
Lichtstrom	3100-3300lm.		3950-4200.		4850-5200lm.		5350-5700lm.
G.w / n.w.	13,5 / 11.5kgs.		13,5 / 11.5kgs.		13,5 / 11.5kgs.		13,5 / 11.5kgs.
Packungsgröße	655x655x760mm.		655x655x760mm.		655x655x760mm.		655x655x760mm.

Produktfotos.

YMLED-6109



PRODUCT DIMENSIONS(MM)

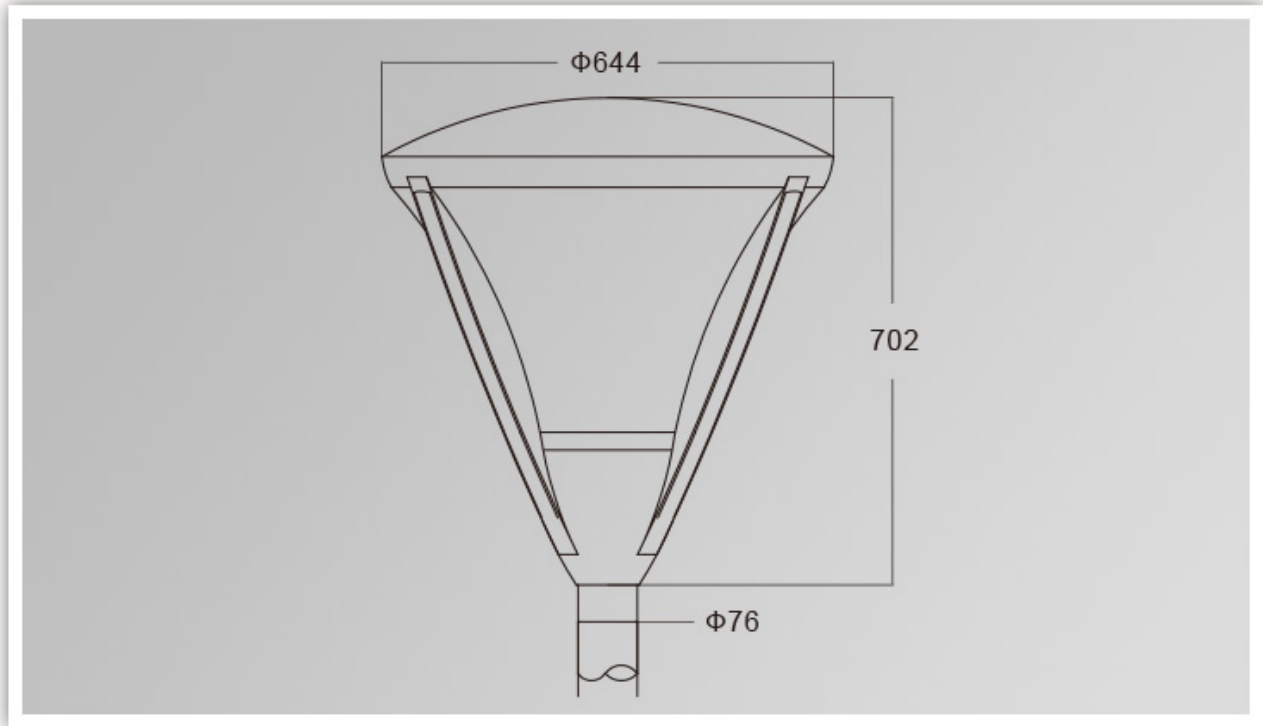

PRODUCT DETAILS



Polar Diagram

Type1

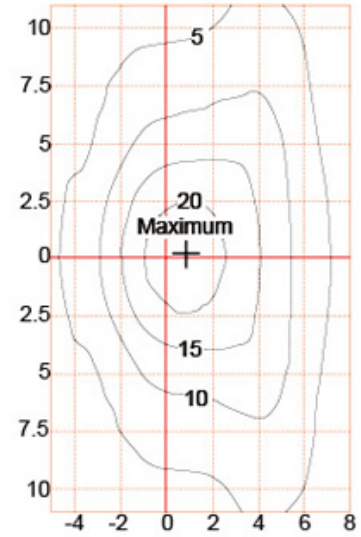
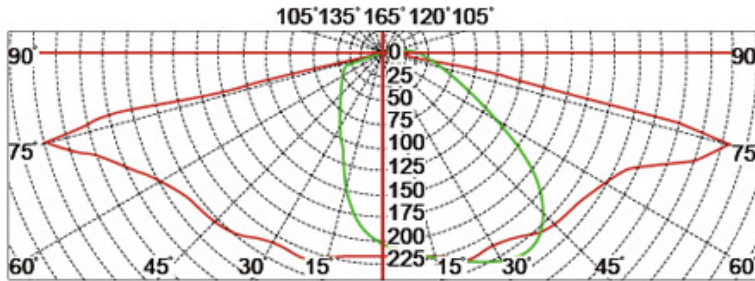

Type2

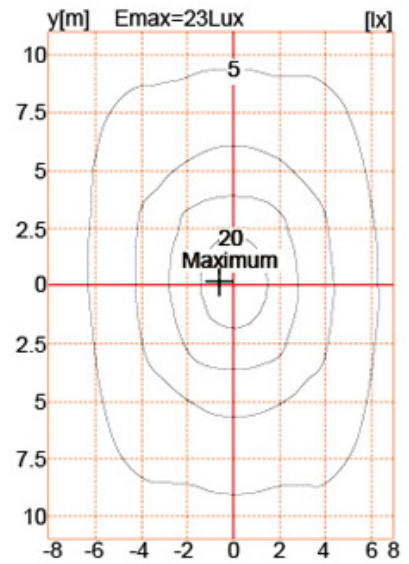
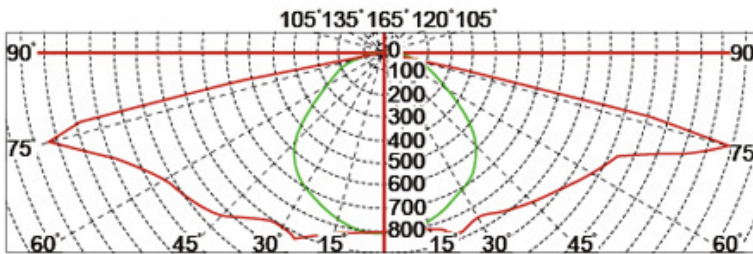

Type3

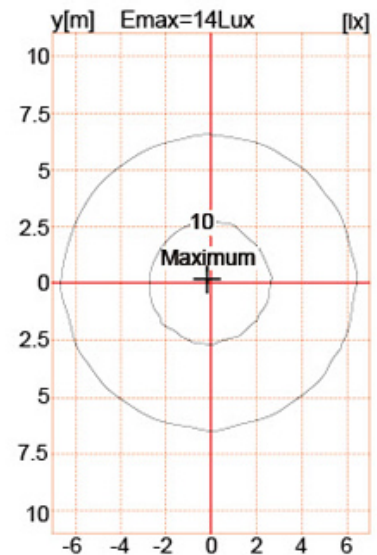
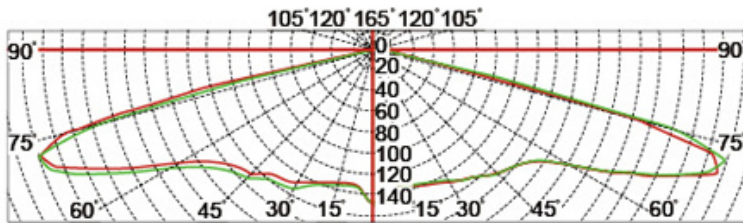

Verpackung & Versand, Handelsbedingungen:

Versand

- 1 FedEx / DHL / UPS / TNT zum Proben, Tür zu Tür,
- 2 Mit der Luft oder auf dem Seeweg zum Chargenwarenfür FCL; Flughafen / Hafen,
3. Kunden, die Spediteure oder verhandelbare Versandmethoden angeben,
- 4 Lieferzeit: 5.-7 Tage für Proben; fünfzehn-30. Tage für Chargenwaren.

Zahlungsbedingungen

1. Zahlung: T / t., Western Union, Moneygram, Paypal 30% Ablagerungen. 70% Restbetrag. vor der Auslieferung,
- 2 MOQ: 1 Stück,
3. Garantie: 5 Jahre